

# **Report**

**EMC Test (Electromagnetic Emission and Immunity) of a Sample Data System Using  
Shielded and Unshielded Cabling Systems at 10BaseT Operation**

**No.**

## **Report 614-A / 99**

**based on EN 45001 – test report 614- A / 99**

Customer ID

**ZVEKE019**

This report comprises 35 pages plus annex.

GHMT mbH and the customers shall grant each other an unlimited right to copy and disclose this report insofar as the measuring results and specifications published are neither modified nor rendered incomplete. Third parties are not permitted to copy this report or excerpts thereof nor misuse it in any other fashion without obtaining our written approval.

## **Table of Contents**

<b><u>1</u></b>	<b><u>GENERAL INFORMATION</u></b> .....	<b>3</b>
1.1	TEST LABORATORY.....	3
1.2	TEST DATE.....	3
1.3	TEST SITE.....	3
1.4	TEST CONDUCTED BY: .....	3
<b><u>2</u></b>	<b><u>CUSTOMERS</u></b> .....	<b>4</b>
<b><u>3</u></b>	<b><u>SUBJECT MATTER AND OBJECTIVE OF THE TESTS</u></b> .....	<b>5</b>
<b><u>4</u></b>	<b><u>EQUIPMENT UNDER TEST</u></b> .....	<b>6</b>
4.1	DESCRIPTION OF EUT (EQUIPMENT UNDER TEST) .....	6
4.2	ARRIVAL OF EUT .....	8
4.3	CONDITION OF EUT AT THE TIME OF TEST .....	8
4.3.1	<i>Basic Configuration of the Data System</i> .....	8
4.3.2	<i>Integration of the Protocol Analyser in the Test Set-Up</i> .....	8
4.3.3	<i>Ethernet Frame Format</i> .....	9
4.3.4	<i>Ethernet Parameters</i> .....	10
4.3.5	<i>Analysis of the Measuring Results</i> .....	12
<b><u>5</u></b>	<b><u>TEST</u></b> .....	<b>14</b>
5.1	TEST TYPE .....	14
5.2	RULES AND REGULATIONS.....	14
5.2.1	<i>Rules and Regulations Applied</i> .....	14
5.2.2	<i>Deviations from Standardized Test Procedures</i> .....	14
5.2.3	<i>Non-standardized Test Procedures</i> .....	15
5.3	CHARACTERISTIC VALUES AND TEST SEVERITY LEVELS.....	16
5.4	DESCRIPTION OF THE MEASURING PARAMETERS.....	18
5.4.1	<i>Electromagnetic Emission</i> .....	18
5.4.2	<i>Electromagnetic Immunity</i> .....	19
<b><u>6</u></b>	<b><u>TEST EQUIPMENT</u></b> .....	<b>24</b>
<b><u>7</u></b>	<b><u>TEST SET-UPS</u></b> .....	<b>25</b>
7.1	OVERALL SET-UP.....	25
7.2	FRONT VIEW OF THE EUT.....	27
7.3	REAR VIEW OF THE EUT.....	27
<b><u>8</u></b>	<b><u>TEST POINTS</u></b> .....	<b>28</b>
<b><u>9</u></b>	<b><u>DOCUMENTATION PHOTOS</u></b> .....	<b>29</b>
<b><u>10</u></b>	<b><u>TEST RESULTS</u></b> .....	<b>30</b>
10.1	OVERVIEW .....	30
10.1.1	<i>Electromagnetic Emission - EN 55022* and Additional Tests*</i> .....	30
10.1.2	<i>Electromagnetic Immunity - EN 50082-2* and Additional Tests*</i> .....	30
10.2	COMMENTS.....	31
10.2.1	<i>Electromagnetic Emission - EN 55022* and Additional Tests*</i> .....	31
10.2.2	<i>Electromagnetic Immunity - EN 50082-2*</i> .....	31
<b><u>11</u></b>	<b><u>SIGNATURE</u></b> .....	<b>33</b>
<b><u>12</u></b>	<b><u>TEST RECORDS</u></b> .....	<b>35</b>

# **1 General Information**

## **1.1 Test Laboratory**

**GHMT mbH**  
Gesellschaft für Hochfrequenz-Meßtechnik mbH

In der Kolling 13

**D-66450 Bexbach**

Phone: +49 / 68 26 / 92 28 - 0

Telefax: +49 / 68 26 / 92 28 - 99

## **1.2 Test Date**

20 October 1999 to 11 February 2000

## **1.3 Test Site**

Kaiserslautern University  
AG EMV  
Paul-Ehrlich-Straße, Absorberhalle Bau 19

**D-67663 Kaiserslautern**

## **1.4 Test Conducted by:**

P. Gessner, engineer, GHMT mbH  
A. Obst, engineer, GHMT mbH  
D. Wilhelm, engineer, GHMT mbH  
P. Leiß, engineer, Kaiserslautern University  
M. Metzger, engineer, Kaiserslautern University

## **2 Customers**

The test series were conducted at the instigation of the following companies (in alphabetical order), who also covered the cost incurred:

Albert Ackermann GmbH + Co. KG  
Alcatel Kabel AG & Co.  
BTR Blumberger Telefon und Relais Vertriebs GmbH  
Corning Cable System  
Dätwyler Kabel + Systeme GmbH  
Kerpenwerk GmbH & Co.  
LEONI Kabel GmbH & Co. KG  
NK Networks GmbH  
Telegärtner Karl Gärtner GmbH

The test series were coordinated by:

Wolfgang Weidhaas, physicist  
Fachverband Kabel und isolierte Drähte  
(Cabling and Insulated Wiring Trade Association)  
Schanzenstraße 30

### **D-51063 Köln (Cologne)**

Phone: +49 / 221 / 96 228 - 36  
Telefax: +49 / 221 / 96 228 - 31  
email: weidhaas.fachverband@t-online.de

### **3 Subject matter and objective of the tests**

The Electromagnetic Compatibility of equipment and systems depends on several factors, which cannot always be discussed separately. The interaction between devices and their cable connections exerts a major influence on a system's EMC behaviour.

The purpose of the tests documented in this report was to investigate the effects of shielded and unshielded cabling systems of the same performance class (link performance class E) on the EMC behaviour of a data system. Accordingly, identical active systems (switch, personal computers with network adapters) and test conditions (workload, hardware and software configuration) were used in both test set-ups.

Despite recent revision, current standards leave some scope in terms of the test set-up for conducting laboratory tests on information technology equipment (ITE). The set-up used for these tests was specified in consultation with all the companies involved in the project, and was designed to include as many influencing factors as possible that are relevant in practice. These considerations were reflected, for example, in the lengths of cable used (10m and 90m), in the cable rack and in the way the active components were connected.

The results obtained in the test and the comments contained in this report relate to the EUT (Equipment Under Test) used and the test set-up described.

To ensure that system performance be assessed as objectively as possible, all passive components were ordered from resellers via third parties. The shielded cabling system was ordered as a mix&match system (cables and components from various manufacturers) according to the customers' specifications, whereas the unshielded cabling system was ordered as a complete system (all components supplied by one manufacturer).

The systems were installed by the GHMT laboratory staff according to the specifications provided by the manufacturer. A conventional field test instrument (Fluke DSP 4000) was used to conduct the standard check for the correct installation of the cabling links (10m and 90m) used in the test set-up prior to starting the EMC test.

Both systems underwent a complete link performance laboratory test for their adherence to Class E limits and were found to meet these requirements. For reasons of clarity, the results obtained in the measurements are documented in the test reports 615/99 A and B.

At the customers' request, this report uses wildcard characters for the manufacturers of the cabling systems and the part numbers in order to avoid any distorted competition between the companies involved in the project. The results listed in the following report refer to the EUT described completely in original test report 614/99. In addition, the report includes a more detailed description of the error patterns obtained.

## **4 Equipment Under Test**

Definition of the terms UTP and STP, which are used in the report:

UTP stands for Unshielded Twisted-Pair Cabling (100Ω)

STP stands for Shielded Twisted-Pair Cabling (100Ω)

### **4.1 Description of EUT (Equipment Under Test)**

Information technology equipment (ITE), data system in 10BaseT client/server operation

#### **System/distributor side (identical for equipment with shielded and unshielded cabling systems):**

- 1 x **Rittal DKS, LAN closet**, 0.8m x 0.8m with hinged 19" frame and vertical grounding kit, glazed door

#### **Active systems (identical for equipment with shielded and unshielded cabling systems):**

- 1 x **Lucent Switch P120**

Basic module CajunP120	CS:	0.3	
Expansion module CajunX120F2	CS:	0.1	
SW versions	Bank A:	1.0	Bank B: 1.0
SW version in use		1.0.21	
Mng MAC address		00-40-0D-88-3C-F2	
- 2 x **Siemens-Nixdorf SCENIC 5T/90** PCI, Tower Personal Computer, 90MHz, ISA/PCI bus, CE 95 marking, S 26361-K345-V711, HOS:003 G4/F2, ID: 5064, Service IDs: WK 011557 5073 and WK 011524 5073
- 2 x **Siemens-Nixdorf MCM 1404**, low-emission colour monitor, CE 95 marking, serial numbers BZ 053787 and BZ 061526
- 2 x **3Com Ethernetlink**, ISA bus, shielded RJ 45, serial numbers 16075 and 16076;

### Cabling system of system 1 (unshielded):

- UTP patchcord (4 x 4.5m) from **supplier D Cat. 6** (please refer to test report 614/99 for type & Comcode), 4 twisted pairs, both ends pre-assembled with one RJ45 plug each.
- 1 x unshielded patch panel from **supplier D Cat. 6** (please refer to test report 614/99 for type & Comcode), 24 x RJ 45 according to TIA/-EIA 568-A, version B.
- Unshielded installation cable (1 x 90m) from **supplier D Cat. 6** (please refer to test report 614/99 for type & Comcode), 4 twisted pairs, zero-halogen, installed on patch panel and telecommunications outlet according to TIA/EIA 568-A, version B, and terminated on installation simulation rack as proposed by CENELEC TC46X WG3.
- Unshielded installation cable (1 x 10m) from **supplier D Cat. 6** (please refer to test report 614/99 for type & Comcode), 4 twisted pairs, zero-halogen, installed on patch panel and telecommunications outlet according to TIA/EIA 568-A, version B, and terminated on installation simulation rack as proposed by CENELEC TC46X WG3.
- 2 x telecommunications outlets from **supplier D Cat. 6** (please refer to test report 614/99 for type & Comcode), 1 x RJ45 each for mounting outlets in **single surface-mount outlets** (please refer to test report 614/99 for type & Comcode).

### Cabling system of system 2 (shielded):

- STP patchcord (4 x 4.5m) from **supplier A, 600 MHz, FR/LS0H** (please refer to test report 614/99 for the part numbers), 4 twisted pairs, both ends pre-assembled with one RJ45 plug (**supplier A**) and one blanking grommet each.
- 1 x shielded patch panel from **supplier A Cat. 6** (please refer to test report 614/99 for the part numbers), 19" assembly, 1 U, 24 x shielded RJ 45.
- STP installation cable (1 x 90m) from **supplier B** (please refer to test report 614/99 for the part numbers), J-02YS(C)H 4x2x23/1AWG PimF, zero-halogen, installed on patch panel and telecommunications outlet according to TIA/EIA 568-A, version B, and terminated on installation simulation rack as proposed by CENELEC TC46X WG3.
- STP installation cable (1 x 10m) from **supplier B** (please refer to test report 614/99 for the part numbers), J-02YS(C)H 4x2x23/1AWG PimF, zero-halogen, installed on patch panel and telecommunications outlet according to TIA/EIA 568-A, version B, and terminated on installation simulation rack as proposed by CENELEC TC46X WG3.
- 2 x telecommunications outlets from **supplier C** (please refer to test report 614/99 for the part numbers), 2 x RJ45 each.

## **4.2 Arrival of EUT**

Calendar weeks 40 and 45/99;

All passive components were ordered from resellers via third parties.

## **4.3 Condition of EUT at the Time of Test**

The individual components described under 4.1 were combined to form a (sample) data system. The switch and the relevant patch panel were installed in the data closet. The rear connection of the shielded patch panel to earth was linked to the vertical grounding kit within the closet. The pin assignment of the RJ 45 installation was based on TIA/EIA568-A version B.

### **4.3.1 Basic Configuration of the Data System**

Both PCs were equipped with the Windows 95 operating system and connected to each other via a 10 Mbps Ethernet in half duplex operation. An audio/video file was used as application, which was started and played in Windows Media Player from the other PC in each case. This practical application was chosen because it permitted immediate recognition of a drop in system performance or of a system crash. Whereas fluctuating utilization with sporadic drops in performance may certainly be deemed as normal for file transfers, the utilization in the case of an audio/video stream is constant. This test set-up thus guarantees direct recognition of any deviations in the behaviour of the sample data system. The virtual RAM of both PCs was shut off in order to prevent them from storing the audio/video stream internally instead of receiving the data via the network.

### **4.3.2 Integration of the Protocol Analyser in the Test Set-Up**

The sample data system was linked to the Lucent Cajun P120 switch by means of a fibre optic connection, which ensured that for the entire measurement duration any interference in the sample data system was prevented from affecting the test set-up and distorting the test results.



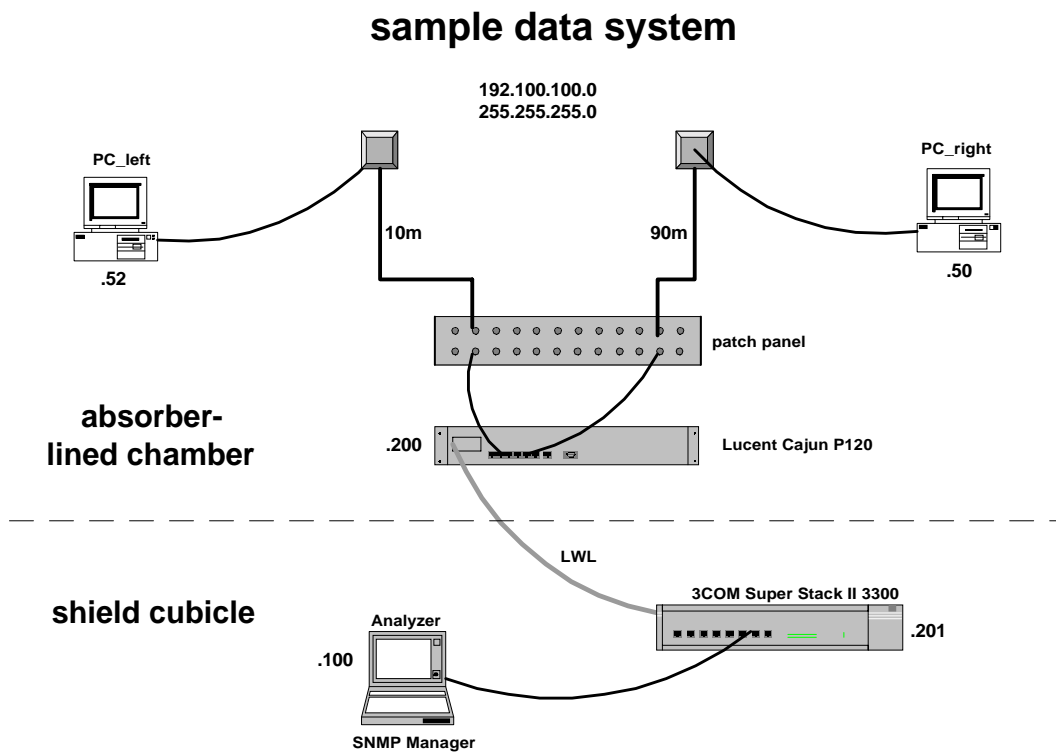

Figure 1: System configuration diagram

The parameters described in the following section were evaluated with the Triticom LAN Decoder SNMP Manager. It permits a readout of the RMON-MIB of the Lucent Cajun P120 switch by means of the SNMP protocol. Since the dwell time per application frequency was 3 seconds during the interference measurements, the values were read out every second and then processed graphically. It was thus possible to allocate detected error conditions to specific frequencies. The parameter readout will be described in greater detail in the next chapter.

### 4.3.3 Ethernet Frame Format

For a better understanding of the measuring data analysis, this section briefly describes the Ethernet frame format:

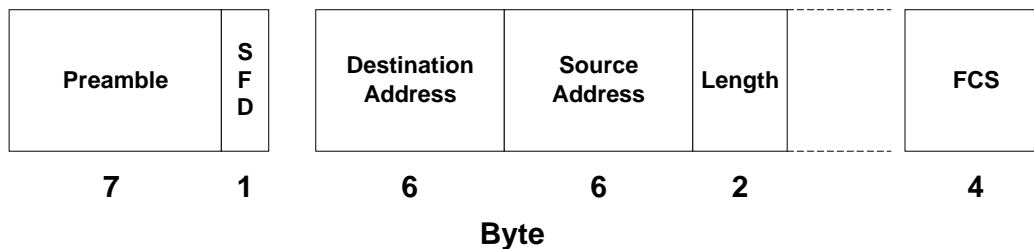

Figure 2: Ethernet Frame Format according to IEEE 802.3

#### Preamble

The preamble is required for the synchronization of the receiver. Each packet is preceded by a 7-Byte sequence of 10101010 combinations.

<b>SFD</b>	The Start Frame Delimiter serves as a signal indicating the beginning of the frame to the receiver. It is transmitted upon completion of the preamble and contains the bit combination 10101011.
<b>Destination Address</b>	6-Byte destination address
<b>Source Address</b>	6-Byte source address
<b>Length</b>	2-Byte length field
<b>FCS</b>	The <u>F</u> rame <u>C</u> heck <u>S</u> equence is a 4-Byte character (CRC 32, 32 bit long <u>C</u> yclic <u>R</u> edundancy <u>C</u> heck) which is appended to the frame. The check is carried out in bit mode. Incomplete bytes (alignment error) therefore do not necessarily have to include an FCS error.

According to the RMON MIB definition (RFC 1757), Ethernet frames are classified as *good packets* or *bad packets*:

Good Packets:

Good packets are error-free packets of a valid frame length (between 64 and 1,518 bytes). This corresponds to the definition laid down in IEEE 802.3.

Bad Packets:

Bad packets show a correct framing (preamble + SFD) but include errors such as invalid length or FCS errors.

#### 4.3.4 Ethernet Parameters

The following parameters form part of the RMON-MIB of the Lucent Cajun P120 switch, which was used to analyse the measuring results:

- Ethernet Octets
- Ethernet Packets
- Drop Events
- CRC/Alignment Error
- Undersize
- Oversize
- Fragments
- Jabbers
- Collisions

**Ethernet Octets** Total number of bytes (including those in faulty packets) received per port (excluding preamble/SFD but including FCS bytes).

<b>Ethernet Packets</b>	Total number of packets received per port (including broadcasts, multicasts and faulty packets).
<b>Drop Events</b>	Total number of events in which the switch drops packets due to a lack of resources. This figure is not equivalent to the number of lost packets. It is merely a measure of the number of events in which the disposal of packets was recognized.
<b>CRC/Alignment</b>	Total number of packets found to have a length between 64 and 1,518 bytes and a CRC/alignment error (including FCS bytes). The figure also includes packets with either a faulty FCS and a multiple of 8 bits (FCS error) or with a poor FCS and no multiple of 8 bits (alignment error).
<b>UnderSize</b>	Total number of packets found to fall short of a length of 64 bytes (including FCS bytes) but which otherwise do not include any errors.
<b>OverSize</b>	Total number of packets found to exceed a length of 1,518 bytes (including FCS bytes) but which otherwise do not include any errors.
<b>Fragment</b>	Total number of faulty packets which have a length of under 64 bytes (including FCS bytes). The figure also includes packets with either a faulty FCS and a multiple of 8 bits (FCS error) or with a poor FCS and no multiple of 8 bits (alignment error).
<b>Jabber</b>	Total number of faulty packets which exceed a length of 1,518 bytes (including FCS bytes). The figure also includes packets with either a faulty FCS and a multiple of 8 bits (FCS error) or with a poor FCS and no multiple of 8 bits (alignment error).
<b>Collisions</b>	The best possible estimate of the number of collisions per port.

### 4.3.5 Analysis of the Measuring Results

Port 2 (10 m link) and Port 11 (90 m link) were used for data transmission during all measurements, as shown in the picture, below.

The LAN Decoder provided the evaluation of the Ethernet parameters initially in the form of a table by way of reading out the Ethernet statistics table in the switch:



Port	etherStatsOctets	etherStatsErrors	etherStatsCRCAlignErrors	etherStatsCollisions	etherStatsBroadcastPkts	etherStatsMulticastPkts	etherStatsUnicastPkts	etherStatsCollisions	etherStatsCollisions
101	0	0	0	0	0	0	0	0	0
102	0	0	0	0	0	0	0	0	0
103	0	0	0	0	0	0	0	0	0
104	0	0	0	0	0	0	0	0	0
105	0	0	0	0	0	0	0	0	0
106	0	0	0	0	0	0	0	0	0
107	0	0	0	0	0	0	0	0	0
108	0	0	0	0	0	0	0	0	0
109	0	0	0	0	0	0	0	0	0
110	0	0	0	0	0	0	0	0	0
111	0	0	0	0	0	0	0	0	0
112	0	0	0	0	0	0	0	0	0

Figure 3: RMON Ethernet statistics table of the Lucent Cajun P120

The values shown were updated every second. To ensure a clear overview during the monitoring procedure, the parameters Octets (bytes) and CRC/Alignment Errors were depicted graphically:

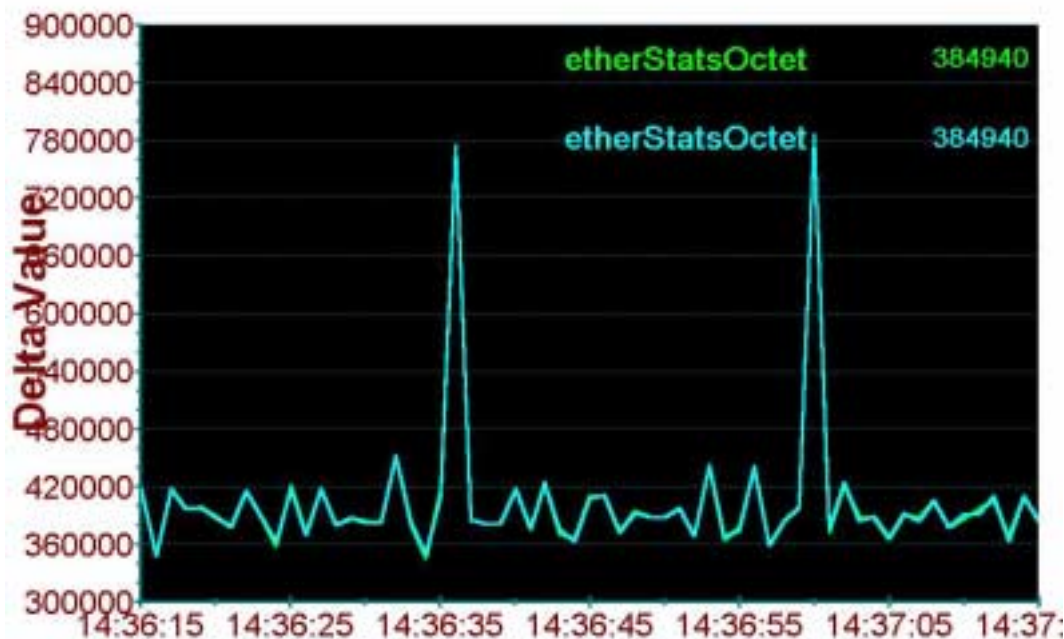
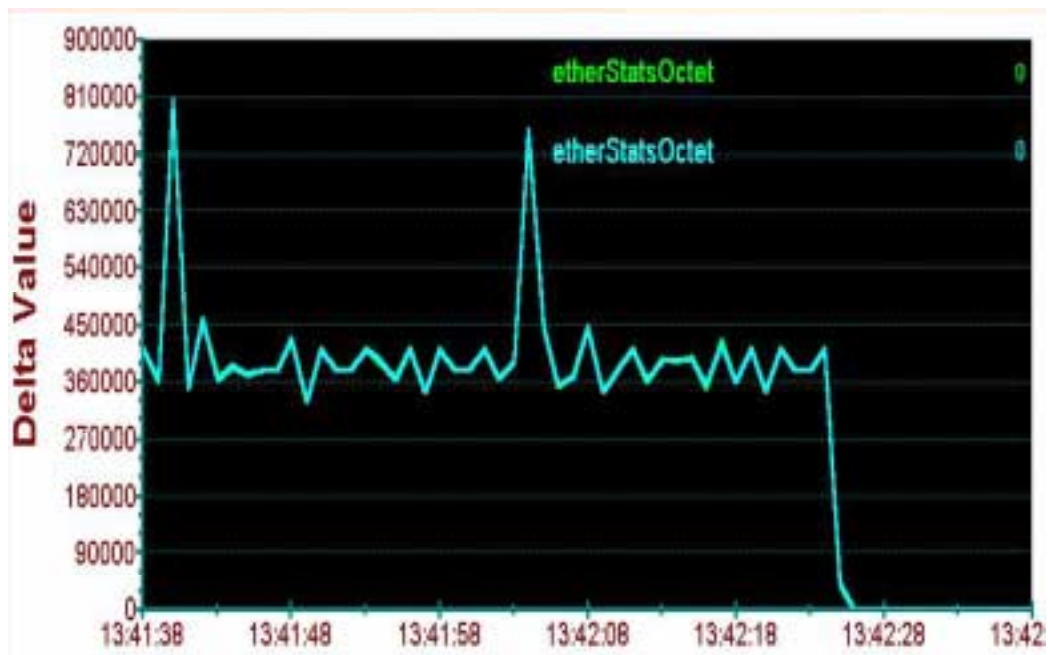

Figure 4: Bytes per second during data transmission in normal condition

Undisturbed data transmission was in the range of approximately 400,000 bytes per second. The peak values that occurred at a regular interval of roughly 20 seconds represent queries conducted within the switch. These peak values also occurred under load-free operation and were not caused by the two PCs or their applications. In addition, the two switch ports (ports 2 and 11) were constantly monitored so as to permit immediate detection of any deviation from normal conditions (identical values resulted in a superimposition of the graphs). The measuring parameter used for identifying a drop in utilization was the number of bytes transmitted per second. The number of bytes transmitted per second and utilization are directly proportional, which explains why it is possible to identify a drop in utilization on the basis of a drop in the number of bytes per second. This becomes clear from the following figure:



**Figure 5: Drop in the number of bytes per second due to an application failure**

It is an inherent feature of half-duplex transmission that collisions may occur. It will only be possible to detect the simultaneous occurrence of a CRC/alignment error and a drop in utilization if a faulty packet initially shows a valid framing (see definition of good/bad packets) so that a bit error may be recognized within the packet. In the case of interference that has a stronger impact on the transmission, the switch is no longer able to identify the framing and thus the entire packet. This led to a rapid decrease in utilization without further Ethernet errors occurring.

## 5 Test

### 5.1 Test Type

Electromagnetic compatibility test.

### 5.2 Rules and Regulations

#### 5.2.1 Rules and Regulations Applied

Electromagnetic emission:

DIN EN 55022 (VDE 0878 part 22): 1998-04: limit class B

Additional Tests:

DIN VDE 0878 part 1: 1986-12: limit according to communication of 01/99  
in the Official Journal No. 1, 1999  
(RegTP-Mitteilung 01/99)

Electromagnetic immunity:

DIN EN 50082-2 (VDE 0839 part 82-2):1996-02

DIN EN 55024 with more stringent requirements according to DIN EN 50082-2  
(Immunity standard: Industrial environment)

DIN VDE 0847 part 4-2:1996-03 (EN 61000-4-2:1995)

DIN VDE 0847 part 4-3:1997-08 (EN 61000-4-3:1996)

DIN VDE 0847 part 4-4:1996-03 (EN 61000-4-4:1995)

DIN VDE 0847 part 4-5:1996-09 (EN 61000-4-5:1995)

DIN VDE 0847 part 4-6:1997-04 (EN 61000-4-6:1996)

Additional Tests:

DIN VDE 0847 part 4-8:1997-04 (EN 61000-4-8:1996)

DIN VDE 0847 part 4-9:1997-04 (EN 61000-4-9:1996)

#### 5.2.2 Deviations from Standardized Test Procedures

##### 5.2.2.1 Electromagnetic Emission

In addition to the requirements specified in EN 55022, the (magnetic) radio noise field strength was examined in the frequency ranges from 9 kHz to 30 MHz and from 1 GHz to 2 GHz.

**(Magnetic) Radio Noise Field Strength in the Range from 9 kHz to 30 MHz:**

Procedure according to DIN VDE 0878 part 1: 1986-12, however, with limit based on communication 01/99 in the Official Journal No. 1, 1999, for the protection of primarily allocated radio communication services (utilization provision No. 30)

### **Radio Noise Strength in the Range from 1 to 2 GHz:**

Procedure according to DIN EN 55022, however, extension of the measuring frequency range up to 2GHz. Limit derived from DIN VDE 0875, part 11:1992-07, table 6 "Grenzwerte für die Funkstörstrahlung zum Schutz besonderer Sicherheits-Funkdienste in bestimmten Gebieten"<sup>1</sup> (47 dB $\mu$ V/m in 3 m up to 2 GHz instead of up to 1.215 GHz)

#### **5.2.2.2 Electromagnetic Immunity**

Besides the requirements specified in EN 50082-2, additional parameters were checked. Besides the requirements specified in EN 55024, additional parameters were checked and more stringent test severity levels were applied. Test criterion A was applied to all parameters.

### **Power Frequency Magnetic Field Immunity Test at 50 Hz:**

Instead of applying power-frequency magnetic fields as described in EN 61000-4-8, interference current was supplied to the shield of the data transmission cabling used. The disturbance is generated by means of a variable-voltage isolating transformer with a current-limiting protective resistor. The output terminals of this interference unit were connected on the one hand to the earth tag of the patch panel and on the other hand to the shield of the installation cable to be tested, in the proximity of the telecommunications outlet. The corresponding data terminal was supplied with current by means of an isolating transformer in order to avoid parasitic currents via the mains leads (PE) of the active components. A clamp-on probe was used for determining the r. m. s. value of the 50 Hz parasitic current supplied.

### **Pulse Magnetic Fields:**

The EUT is surrounded by a single-turn coil which apart from its inductive resistance constitutes a generator short circuit. EN 61000-4-9 specifies coil sizes of 1 m x 1 m and 1 m x 2.6 m. The field-generating coils described were replaced by a coil of size 2.5 x 2.5 m in order to embrace the overall set-up. The conductor forming the single-turn coil was accommodated in a pivoted plastic tube attached to the cable rack.

#### **5.2.3 Non-standardized Test Procedures**

None.

---

<sup>1</sup> *Limits of radio disturbance for the protection of special security radio communication services in specific environments*

### 5.3 Characteristic Values and Test Severity Levels

#### Electromagnetic Emission:

DIN EN 55022: limit class B (VDE 0878 part 22, 05/1995)

DIN VDE 0878 part 1: 1986-12: limit according to communication of 01/99  
in the Official Journal No. 1 of the year 1999  
(RegTP-Mitteilung 01/99)

Parameter	Test severity level	Frequency	Measuring point
Radio noise voltage	Quasi peak, class B 66 to 56 dB $\mu$ V, linear decr. log f 56 dB $\mu$ V 60 dB $\mu$ V	0.15 – 0.5 MHz 0.5 – 5 MHz 5 – 30 MHz	Mains lead of all active components
Radio noise field strength	Quasi peak 3m, class B 40 dB $\mu$ V/m 47 dB $\mu$ V/m 47 dB $\mu$ V/m	30- 230 MHz 230 – 1,000 MHz (1,000-2,000) MHz	Overall system
Additional tests			
(Magnetic) radio noise field strength	Peak 3m, RegTP 1/99 40- 20 log (f/MHz) dB $\mu$ V/m 40- 8.8 log (f/MHz) dB $\mu$ V/m	0.009 – 1 MHz 1 – 30 MHz	Overall system

#### Electromagnetic Immunity:

DIN EN 50082-2 (VDE 0839 part 82-2):1996-02 with additional tests

DIN EN 55024 with more stringent requirements according to DIN EN 50082-2  
(Immunity standard: Industrial environment)

Parameter	Test Severity Level	Characteristic value	Coupling point	Standard
Electrostatic discharge (ESD)	Contact: 4 kV  Air: 8 kV  Coupling 4 kV	$t_r = 0.7- 1$ ns	Any tangible metallic parts in the case of "contact discharge"; any insulated "air", system vertical or horizontal coupling plane	EN 61000-4-2:1995
Radiated, radio-frequency, electromagnetic field immunity	10 V/m	80-1,000 MHz AM: 80% AF: 1 kHz  900 $\pm$ 5 MHz, PM: 50% duty cycle AF : 200 Hz	application to the entire system	EN 61000-4-3:1996



Parameter	Test Severity Level	Characteristic value	Coupling point	Standard
Electrical fast transient/burst immunity	data t. c.: 1 kV mains l.: 2 kV	5/50 ns, 5 kHz	Data transmission cables in the vicinity telecommunications outlets and panels; mains lead of all active components	EN 61000-4-4:1995
Surge immunity	2/4 kV	1.2/50 $\mu$ s	mains lead of all active components	EN 61000-4-5:1995
Conducted disturbance induced by radio frequency fields immunity	e.m.f. 10 V	0.15-80 MHz AM: 80 % AF: 1 kHz	Data transmission cables in the vicinity telecommunications outlets and panels; mains lead of all active components	EN 61000-4-6:1996
<b>Additional tests</b>				
Compensating currents Power frequency magnetic field immunity	$I_{\text{eff}} = 1 \text{ A}$	50 Hz	Data transmission cables (only possible with shielded system)	adapted from EN 61000-4-8:1996
Pulse magnetic fields	up to 300 A/m	rise time 10 $\mu$ s	overall system	adapted from EN 61000-4-9:1996

## 5.4 Description of the Measuring Parameters

### 5.4.1 Electromagnetic Emission

The limitation of the electromagnetic emission values serves primarily to protect radio communication services, such as the reception of TV broadcasts, police radio or aeronautical radio service, etc.

The choice of method will depend on the frequency range and on the properties of the EUT. Various measuring methods are used for assessing electromagnetic emission. These methods will be described briefly in the following section.

<b>Radio noise voltage, mains terminals, 0.15 MHz-30 MHz Limit class B</b>
--

For data systems, radio noise voltage is measured on the mains lead of the active components. What is generally referred to as V-AMN (Artificial Mains Networks) are used for measuring the radio noise voltage. These artificial mains networks define a specific network impedance in the test set-up, protect the network against disturbance, since these must not be included in the measurements, and also shut off the line voltage from the measuring receiver input.

Apart from the quasi peak value, an average limiting value that is lower by 10 to 13 dB is specified for the radio noise voltage values which are to be determined in the frequency range between 150 kHz and 30 MHz. Both limits have to be adhered to.

The distinction between limit class A and limit class B (more stringent) corresponds to the distinction between industrial environments and residential environments.

The measuring results are thus largely independent of the EMC quality of the data transmission cable connections.

<b>Radio noise field strength at a measuring distance of 3 m, 30 – 1,000 (2,000) MHz Limit class B</b>
--

The electrical component of the radio noise field strength is measured by means of plane-polarized antennae. This requires measuring runs with horizontal and vertical polarization. The entire sample system is mounted on a turntable since with the antenna being stationary, the system's emissions will have to be measured from various positions. The measuring distance between antenna and EUT is 3 m.

In order to take the new mobile communications services (DECT and GSM) into account, the standard frequency range currently specified in the EN 55022 standard was extended in the test to include frequencies up to 2,000 MHz.

The distinction between limit class A and limit class B (more stringent) corresponds to the distinction between industrial environments and residential environments.

The strength of the field radiated is affected by the EMC quality of the data transmission cable connections and by the active components in the measuring room.

**(Magnetic) radio noise field strength at a measuring distance of 3 m,  
9 kHz – 30 MHz  
Limit: RegTP<sup>2</sup> recommendation from 1/99**

Hitherto, matters have been simplified by assuming that radiated emission from housings and wiring is negligible below 30 MHz and that only conducted disturbance (radio noise voltage), as dominant variable, need be tested.

Current disturbance reports from aeronautical radio and amateur radio services, however, contradict this definition and clearly show the necessity of defining radio noise voltage limits from 9 kHz to 30 MHz. The ever-increasing use of ADSL, XDSL and LAN networks has thus prompted a renewed discussion about the limits of measuring parameters for magnetic field strength (9 kHz – 30 MHz). National and international standardization bodies are now striving to define field strength limits even below 30 MHz. In January 1999, the German regulatory authority RegTP introduced a stringent limit into the discussion in order to ensure coverage of the long, medium and short wave ranges.

The strength of the field radiated is affected by the EMC quality of the data transmission cable connections and by the active components in the measuring room.

#### 5.4.2 Electromagnetic Immunity

The immunity tests currently prescribed by the generic standards applicable to residential and industrial environments are described in the generic standards IEC 1000-4-x and EN 61000-4-x. The electromagnetic immunity of the sample system in a representative operating condition is tested by way of simulating disturbances characteristic of the individual environment. The system's working order is monitored through appropriate measuring instruments (in this case a protocol analyser). The minimum operating quality was specified by the customers in the run-up to the test. Due to the stringent availability requirements laid down by the network operators in most applications (fail-safe mode, error-free system operation under any conditions if possible), the test criterion chosen for all test parameters was "A". This means that no impairment of the utilization will be tolerated during the exposure stage. The occurrence of individual CRC errors was only permitted if there was no reproducibility at a specific frequency, and if no concomitant decrease in utilization was detected.

As test severity level, the more stringent requirements to be met by industrial environments were chosen, since a large number of disturbing phenomena exceed the less stringent residential and commercial requirements (for instance 2W GSM mobile phones)

For every phenomenon to be simulated, there is a corresponding generic standard.

---

<sup>2</sup> German regulatory authority responsible for telecommunications and mail services

**Electrostatic discharge****Test severity level: contact discharge 4 kV, air discharge 8 kV, coupling plane 4 kV****Test criterion: A**

The growing use of electrostatically sensitive semiconductor devices increases the importance of protection against transient currents and fields generated during electrostatic discharge. This development was taken into consideration in test specification EN 61000-4-2.

As regards the selection of test points, all those parts of the EUT will qualify that are accessible to the service staff in the usual handling of the device, including maintenance. At least 10 pulses per polarity must be applied to every point, with the minimum time between two subsequent pulses not falling below one second.

Immunity to this phenomenon is affected by the EMC quality of the data transmission cable connections and by the active components, which are likewise exposed to electrostatic discharge.

**Radiated, radio frequency, electromagnetic field immunity, 80- 1000 MHz****Test severity level: 10 V/m****Test criterion: A**

The sample system was positioned in front of the field-generating antenna in the absorber-lined chamber (ALC). The test signals used are sinusoidal carrier signals in the frequency range from 80 MHz to 1 GHz, which are amplitude-modulated with a low-frequency sinusoidal voltage (80% swing) (see section EN 61000-4-6). In addition mobile radio communications is simulated by means of pulse modulation at 900 MHz.

Earlier specifications (IEC 801-3) merely prescribed examination of the frequency range from 26 to 500 MHz, without amplitude modulation. This standard is listed in a generic standard on electromagnetic immunity in the residential environment, etc. The latter standard has been revised but will continue to be valid until the middle of 2001 (EN 50081-2:1992). However, since it has been found that the AM test puts more stringent requirements on the EUT, qualification according to the outdated standard will be dispensed with.

Based on the finding that most electronic equipment is affected by electromagnetic fields, potential sources of interference also include hand-held walkie-talkies, stationary radio or TV stations or even industrial RF sources. In addition, tests are carried out at around 900 MHz (D network) for frequencies that are typical of mobile radio communications.

Immunity to this phenomenon is affected by the EMC quality of the data transmission cable connections and by the active components, which are likewise exposed to electromagnetic radiation.

**Exposure to fast transient currents (burst)****Test severity level: data transmission cables 1 kV, mains leads 2 kV****Test criterion: A**

If the switch in a circuit that contains inductive loads (relay, contactor, fluorescent lamps) is opened, the entire voltage induced in the coil by means of the fast change in the current and thus in the flux acts across the switch contacts and ignites the relatively small air gap. As the flow of current resumes, the voltage across the switch contacts decreases, and the spark is extinguished. This process is repeated several times and gives rise to pulse packets which represent a potential disturbance due to their high-frequency components (up to several hundred MHz) and their high voltages (up to several kV). This phenomenon, which is generally known as burst, is simulated in the laboratory with what is usually referred to as a burst generator. The procedure is described in EN 61000-4-4.

The individual pulse was defined as a 5/50 ns pulse voltage, with the pulse packets being generated at a repetition rate of 5 kHz.

As far as mains leads are concerned, the disturbance is introduced by means of a coupling/decoupling network with a maximum of seven coupling variants (L, N, PE, L+PE, N+PE, L+N, L+N+PE). Mains leads which run parallel to the data transmission cables and which are subject to such burst potentials are simulated by way of placing the data transmission cable in a capacitive clamp-on coupling, to which the generator feeds its pulse packets.

Immunity to this phenomenon is affected by the EMC quality of the data transmission cable connections and by the active components, which are likewise subjected to transient currents.

**Exposure to surges****Test severity level: mains leads 2/4 kV****Test criterion: A**

Atmospheric discharges and even the actuation of switches in the power supply system generate high-energy overvoltages of various wave shapes. These can cause interference in electrical devices or, in the worst of cases, even destroy electrical devices. Since not all types of overvoltage encountered in practice can be used when testing immunity to surge pulses, the authors of the EN 61000-4-5 standard agreed on the use of the lightning impulse wave shape of 1.2/50  $\mu$ s. The laboratory simulation uses a combination-wave generator.

Coupling into mains conductors is effected in a capacitive manner in order to decouple the generator output from the mains voltage. The power supply network is kept free from test pulses by means of additional series inductors in the coupling/decoupling network. Surges were not applied to fast data transmission cables since coupling networks of this type have a strong impact on the transmission properties of such cables. For the aforementioned reasons, immunity with this type of test does not depend on the EMC quality of the data transmission cable connections. However, the pulse magnetic field immunity test (EN 61000-4-9) takes this condition into account, since here the entire system is subjected to surges.

**Introduction of conducted RF disturbance****Test severity level: data transmission cables e.m.f. = 10 V, mains leads e.m.f. = 10 V****Test criterion: A**

One assumes that the RF energy radiation in the lower frequency range is mainly absorbed by means of the EUT wiring connections. For this reason, radiation below 80 MHz is forgone and the interference signal is fed directly into the mains conductor and the data transmission cable connections of the EUT via coupling-decoupling networks or clamp-on probes. The main sources of interference in this frequency range include radio and TV stations, walkie-talkies and ISM devices.

The test signal consists of a sinusoidal RF signal ( $f = 0.15 - 80$  MHz; amplitude modulation: 80% in depth by a 1 kHz signal) at the test. The listed e. m. f. value of 10 V is the no-load r.m.s. value of the amplifier output voltage. This is applied to the clamp-on input device in which the data transmission cable is placed, so that the cable is directly subjected to the disturbance.

Immunity to phenomenon is affected by the EMC quality of the data transmission cable connections and by the active components, which are likewise subjected to the disturbance.

**Power frequency magnetic field****Test severity level: 1A on shielded data transmission cables****Test criterion: A**

Instead of applying power-frequency magnetic fields as described in EN 61000-4-8, interference current was supplied to the shield of the data transmission cabling used. This simulates the shield currents generated locally in installations whenever the magnetic fields of utility installations (for example transformers, primary distributors, conductor-rail systems) permeate installation loops formed by shielded data cabling in conjunction with the mains leads. The test also simulates equipotential currents between two points connected by the cable shield.

The disturbance is generated by means of a variable-voltage isolating transformer with a current-limiting protective resistor. The output terminals of this interference unit were connected on the one hand to the earth tag of the patch panel and on the other hand to the shield of the installation cable to be tested, in the proximity of the telecommunications outlet. The corresponding data terminal was supplied with current by means of an isolating transformer in order to avoid parasitic currents via the mains leads (PE) of the active components. A clamp-on probe was used for determining the r. m. s. value of the 50 Hz parasitic current supplied.

Immunity to phenomenon is affected by the EMC quality of the data transmission cable connections and by the active components, which are likewise subjected to the disturbance.

**Pulsed magnetic fields****Test severity level: 300 A/m****Test criterion: A**

The test simulates interference encountered in medium-voltage and high-voltage switchplants. However, the findings obtained in this test are also of great importance when it comes to planning a lightning protection zone. To ascertain the required efficiency of the room shields to be employed, one has to know the immunity of the devices to be used in the individual lightning protection zones against the transient fields of the lightning channel and of the current-carrying components of the external lightning protection.

The EUT is surrounded by a single-turn coil which apart from its inductive resistance constitutes a generator short circuit. The standard specifies coil sizes of 1 m x 1 m and 1 m x 2.6 m. To test a minimum but representative set-up, e. g. a data system, larger coils of a suitable size will be required.

The field-generating coils described in EN 61000-4-9 were replaced by a coil of size 2.5 x 2.5 m in order to embrace the overall set-up. The conductor forming the single-turn coil was accommodated in a pivoted plastic tube attached to the cable rack. This facilitates the generation of horizontally and vertically aligned magnetic fields. The coil is fed by a combination-wave generator supplying a current of 8/20  $\mu\text{s}$  with positive and negative amplitudes. The current or magnetic field pulse of 8/20  $\mu\text{s}$  serves to simulate the rising edge of the initial lightning pulse, which has a wave shape of 10/350  $\mu\text{s}$  ( $f_{\text{max}} = 25 \text{ kHz}$ ).

Immunity to phenomenon is affected by the EMC quality of the data transmission cable connections and by the active components, which are likewise subjected to the interference.

## 6 Test Equipment

Device	Description	Manufacturer	Technical data	Serial No.	Last calibration
Measuring room		Siemens	22m*15m*10m	w/o	(06) 07/98
Shield cubicle		Siemens	7.6m* 3.55m* 2.55m	w/o	w/o
Amplifier	BTA0122-2000	Bonn	9 kHz-220 MHz, 2 kW CW	933750 B	w/o
Amplifier	BLWA1010-200	Bonn	100 MHz-1 GHz, 200 W CW	933750 A	w/o
Signal generator	SMY	Rhode & Schwarz	10 kHz-1 GHz	833996/012	09/98
Signal generator	SMGL	Rhode & Schwarz	10 kHz-1 GHz	832681/017	manufacturer
Multi-functional synthesizer	AFS	Rhode & Schwarz	0.001 Hz- 20 MHz	829717/0100	w/o
Log.-period. antenna	AT1080	Amplifier Research	80 MHz-1 GHz, max. 2 kW	12833	w/o
Bilog.-period. antenna	3143 3142	EMCO	30 MHz-1 GHz 30 MHz-2 GHz	1067	10/94
Power meter	NRVD	Rhode & Schwarz		863714/016	manufacturer
Spectrum analyser/ measuring receiver	ESMI	Rhode & Schwarz	20 Hz-26.5 GHz	829088/013 827063/003	11/98
Turntable	DS425	Ing. Büro H. Deisel	d = 2.5 m m <sub>max</sub> = 1000 kg	w/o	w/o
Antenna mast	MA240	Ing. Büro H. Deisel	h = 4 m	w/o	w/o
Burst generator with capacitive coupling and coupling network	EFT 500	EM-Test	up to 1 MHz 4.4 kV	EFT 500-0196-55	08/99
Combination- wave generator	VCS 500	EM-Test	up to 4 kV	VSC 500-0396- 03	08/99
ESD generator with test gun	ESD 30	EM-Test	18 kV	ESD 30-0296-59 P 18 -0296-59	08/99
EM clamp	EM 101	Lüthi	150 kHz-1 GHz	923572	10/99
Movable absorber walls	SFC 48 T	Cuming	70 m <sup>2</sup> as from 80 MHz	w/o	w/o
Ground absorber	SFC 18	Cuming	30 m <sup>2</sup>	w/o	w/o
Ethernet analyser	LAN Decoder SNMP Manager	Triticom	10/100 Mbit/s Ethernet	RBD01933-30BE	w/o

**Table 1:** Test equipment



## 7 Test Set-ups

### 7.1 Overall Set-up

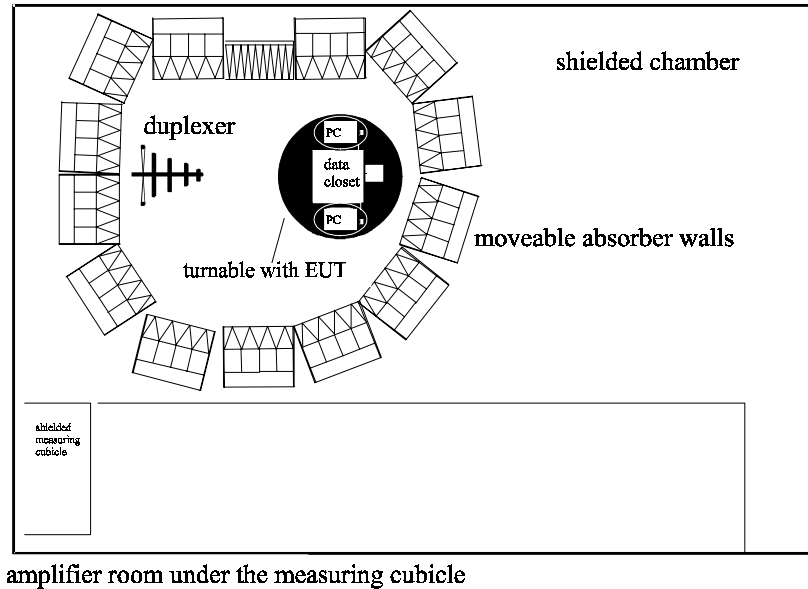

Figure 6: Overview

Before the measurement series was started, the installation cables were arranged on a cable rack as proposed by CENELEC TC 46X WG3 (see documentation photos) in order to achieve a high degree of reproducibility. The unshielded and the shielded cabling systems were each arranged on a separate rack. A 10 m link and a 90 m link were installed for each cabling system in order to simulate the critical cases encountered in practice. Both devices are identical in terms of their mechanical structure and the material used.

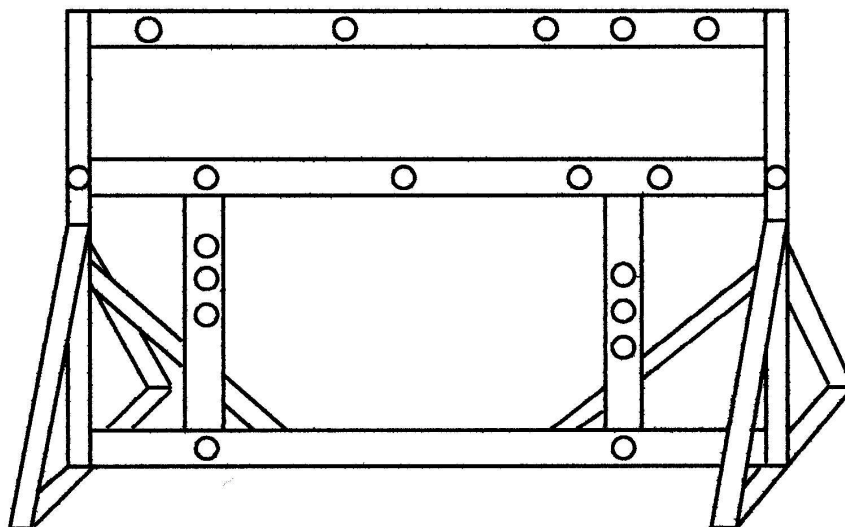

Figure 7: Cable rack

System configurations 1 (unshielded) and 2 (shielded) were tested one after the other. There was thus only one cabling system with 10 m and 90 m installation cable links in the test room during a test.

As soon as the test series for the unshielded system were completed, the cable rack was removed from the test room and replaced by the device that carried the shielded system. The same active systems (switch, personal computers and network adapters) were used in both test series, so that here, too, both cabling systems were tested under the same conditions.

All data system components underwent the tests on a turntable ( $d = 2,5\text{m}$ , height above groundplane =  $0.17\text{m}$ ), which was situated in the absorber-lined chamber. The data closet was placed in the centre of the turntable. The upper half of the hinged 19" frame contained the switch and the patch panel used in each case. The switch and the patch panel were connected to each other by means of the appropriate patch cables (unshielded or shielded) of approx. 4.5 m in length. The installation cables routed through the base panel into the closet were connected to the reverse side of the patch panel. The cable rack was positioned at the rear of the data closet. The two personal computers and their network adapters, monitors and keyboards were placed on wooden tables, which were 0.8 m high and which were positioned at the side of the LAN closet. The installation cables were attached to data outlets on the data terminal side. The outlets and the PCs were linked by means of flexible unshielded or shielded patch cables, which were about 4.5 m long.

## **7.2 Front View of the EUT**

See documentation photos

## **7.3 Rear View of the EUT**

See documentation photos

## **8 Test Points**

### DIN VDE 0847-4-2 (ESD):

- E1: Rear of closed data closet, central screws
- E2: Door of closed data closet, lock
- E3: Data closet inside, 19" angle irons for mounting patch panel
- E4: Data closet inside, 19" switch support
- E5: Patch panel port "10m", RJ45 plug\*
- E6: Patch panel port "90m", RJ45 plug\*
- E7: Horizontal coupling plane "10m"
- E8: Horizontal coupling plane "90m"
- E9: Telecommunications outlet (TO) "10m", RJ45 plug\*
- E10: Telecommunications outlet (TO) "90m", RJ45 plug\*

\* Shielded system: contact/air discharge on the shield

\* Unshielded system: air discharge on the plug body

### DIN VDE 0847-4-4 (Burst):

- B1: Data transmission cable, in the vicinity of the telecommunications outlet, "10m"
- B2: Data transmission cable, in the vicinity of the telecommunications outlet, "90m"
- B3: Data transmission cable, in the vicinity of the patch panel, "10m"
- B4: Data transmission cable, in the vicinity of the patch panel, "90m"
- B5: Switch power supply
- B6: PC 1 power supply
- B7: PC 2 power supply

### DIN VDE 0847-4-5 (Surge):

- S1: Switch power supply\*

\* The test was conducted in one system configuration only.

### DIN VDE 0843-6 (conducted RF disturbances):

- H1: Data transmission cable in TO direction, in the vicinity of the TO, "10m"
- H2: Data transmission cable in TO direction, in the vicinity of the TO, "90m"
- H3: Data transmission cable in patch panel direction, in the vicinity of the patch panel, "10m"
- H4: Data transmission cable in patch panel direction, in the vicinity of the patch panel, "90m"
- H5: Switch power supply
- H6: PC 1 power supply
- H7: PC 2 power supply

## 9 Documentation Photos



**Figure 8:** Sample data system, front view (UTP equivalent)



**Figure 9:** Sample data system, rear view (UTP equivalent)



**Figure 10:** Hinged data closet frame containing switch and patch panel

## 10 Test Results

### 10.1 Overview

#### 10.1.1 Electromagnetic Emission - EN 55022\* and Additional Tests\*

Standard*	Parameter	Limit	System 1 (unshielded)	System 2 (shielded)
EN 55022	Radio noise voltage	Class B	passed	passed
EN 55022	Radio noise field strength	Class B	failed	passed
Additional Tests				
VDE 0878	(Magnetic) radio noise field strength	RegTP 01/99	passed	passed

#### 10.1.2 Electromagnetic Immunity - EN 50082-2\* and Additional Tests\*

Standard*	Parameter	Severity level	System 1 (unshielded)	System 2 (shielded)
EN 61000-4-2	Electrostatic Discharge (ESD)	Contact: 4 kV Air: 8 kV Coupling: 4 kV	passed s. PB 614-B / 99 failed/affected	passed passed passed
EN 61000-4-3	Radiated, radio frequency, electromagnetic field immunity	10 V/m inform: 25 V/m	failed/system crash not tested	passed passed
EN 61000-4-4	Exposure to fast transient/burst	Data t. c.: 1 kV inform: 4 kV Mains l.: 2 kV	failed/ affected not tested passed	passed passed passed
EN 61000-4-5	Exposure to surges	2/4 kV	passed	passed
EN 61000-4-6	Conducted electromagnetic field immunity	Data t. c.: 10 V inform: 25 V Mains l.: 10 V	failed/ affected not tested passed	passed passed passed
Additional Tests				
adapted from EN 61000-4-8	Compensating currents Power-frequency magnetic fields	$I_{\text{eff}} = 1 \text{ A}$	not tested since there was no shield	passed
adapted from EN 61000-4-9	Pulsed magnetic fields	up to 300 A/m	passed	passed

\* Please refer to chapter 5.2, "Rules and Regulations" for detailed specification data and dates of issue

## 10.2 Comments

### 10.2.1 Electromagnetic Emission - EN 55022\* and Additional Tests\*

#### **Radio noise voltage, mains leads – 0.15 MHz-30 MHz**

Systems 1 and 2 meet the requirements of limit class B.

#### **Radio noise field strength at a measuring distance of 3 m, 30 – 1000 (2000) MHz**

System 1 (unshielded) does not meet the requirements of limit class B. The requirements of limit class A are met.

System 2 (shielded) meets the requirements of limit class B.

#### **Magnetic radio noise field strength at a measuring distance of 3 m, 9 kHz – 30 MHz**

Systems 1 and 2 meet the RegTP requirements issued in 01/99.

### 10.2.2 Electromagnetic Immunity - EN 50082-2\*

#### **Electrostatic Discharge(ESD)**

*DIN VDE 0847 part 4-2*

System 1 (unshielded) experienced a slight decrease in utilization during the discharge on the horizontal coupling plane (test points E7/E8). It was not necessary to restart the system.

Since the relevant switch port was destroyed during air discharge on the RJ45 plug inserted in the panel (E5/E6) when the test of the Fast Ethernet service was conducted (test report 614-B / 99), the test was not repeated. The network adapter port was also destroyed during the discharge on the RJ45 plug inserted in the telecommunications outlet (E9/E10) when the Fast Ethernet test was carried out, so that this test was not repeated either.

System 2 (shielded) did not show any transmission errors or other effects with any of the coupling types.

#### **Radiated, radio frequency, electromagnetic field immunity, 80- 1000 MHz**

*DIN VDE 0847 part 4-3*

System 1 (unshielded) experienced a strong decline in data transmission with interference frequencies ranging from 90 to 110 MHz, which even resulted in a system crash. Data transmission had to be re-started.

System 2 (shielded) did not show any transmission errors or other effects even when the field strength was stepped up to 25 V/m.

#### **Exposure to fast transients (burst)**

*DIN VDE 0847 part 4-4*

System 1 (unshielded) experienced a significant drop in utilization when the data transmission cables were subjected to fast transients. However, unlike the Fast Ethernet test (test report 614-B / 99), this did not result in a total data transmission crash.

System 2 (shielded) did not show any transmission errors or other effects, even when the burst voltage was increased to 4 kV.

**Exposure to surges**

*DIN VDE 0847 part 4-5*

Neither of the systems experienced any transmission errors or any other effects.

**Exposure to conducted RF interference**

*DIN VDE 0847 part 4-6*

System 1 (unshielded) experienced a drop in utilization and CRC errors when the data transmission cables were subjected to conducted RF disturbance. However, unlike the Fast Ethernet test (test report 614-B / 99), this did not result in a total data transmission crash.

System 2 (shielded) did not show any transmission errors or other effects even when the e. m. f. was increased to 25 V.

**Power-frequency magnetic fields**

*adapted from DIN VDE 0847 part 4-8*

System 1 (unshielded) was not tested since there was no shield.

System 2 (shielded) did not show any transmission errors or other effects

**Pulsed magnetic fields**

*adapted from DIN VDE 0847 part 4-9*

Neither of the systems experienced any transmission errors or any other effects.

\* Please refer to chapter 5.2, "Rules and Regulations" for specification data and dates of issue



## **11 Signature**

Bexbach / Saar, 14 February 2000



---

Dipl.-Ing. D. Wilhelm  
GHMT mbH, Bexbach

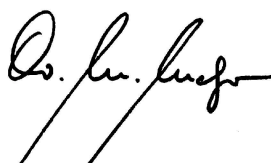

---

Dr.-Ing. M. Metzger  
Kaiserslautern University



## **12 Test Records**

Please refer to the origin test report